



STAGE 1

STAGE 2

STAGE 3



AXEON HYDRO RO-SERIES

High Efficiency Hyperfiltration System

USER MANUAL

AXEON WATER

AXEON WATER

AXEON WATER

#21225

#21225

#21225

TABLE OF CONTENTS

PRECAUTIONS	2-3
FILTER REPLACEMENT SCHEDULE	4-5
SYSTEM INCLUDES	6-7
HYDRO RO-1250	8
HYDRO RO-750	9
SYSTEM INSTALLATION	10-19
SMART CONTROLLER FUNCTIONALITY EXPLAINED	20
PERFORMANCE	21
COMPONENT SPECIFICATIONS	22-23
WARRANTY AND SUPPORT	24
TROUBLESHOOTING	25
FLOW DIAGRAMS	26-27
DIMENSIONAL DRAWINGS	28-31
FILTER REPLACEMENT LOG	32
NOTES	33







WATER PURIFICATION SYSTEMS SINCE 1989









AXEON® Water systems use advanced reverse osmosis membrane technology for removing +96% contaminants from feed water sources. These systems are designed and engineered for maximum flow and efficiency rates, meaning less water down the drain and more purified water for use.

REQUIRED: Read the following user manual for setup and maintenance instructions and to get the maximum performance from your system.

WARNING LABELS

	<p>Caution: Indicates statements that are used to identify conditions or practices that could result in equipment or other property damage.</p>
	<p>Warning: Indicates statements that are used to identify conditions or practices that could result in injury or loss of life. Failure to follow warnings could result in serious injury or even death.</p>
	<p>Electrical Hazard: Indicates statements that are used to identify high-voltage and potential shock/electrocution.</p>

PRECAUTIONS

	<p>Do not use this product with non-potable water sources. Do not use where the water is microbiologically unsafe or of unknown quality without adequate testing and disinfection before or after the system.</p>
	<p>Always turn off the unit, shut off the feedwater, relieve pressure, and disconnect the electrical power before working on the unit.</p>
	<p>Do not operate the system with insufficient feed flow. Never allow the pump to run dry.</p>
	<p>Never allow the unit to freeze or operate with a feedwater temperature above 85 °F.</p>
	<p>The temperature of the water supply to the system must be between 40 °F-85 °F (4 °C-30 °C). Do not install on hot water lines. Hot water heaters can contain a lot of mineral build-up and temperatures may be too hot.</p>
	<p>Inlet/feed water pressure must be between 40 psi - 100 psi. Do not exceed 100 psi.</p>
	<p>High levels of certain contaminants in the incoming water may prematurely foul the membranes and/or the pre-filters. Softened or conditioned water is recommended for optimal system performance and RO membrane life.</p>
	<p>The black ¼" drain line must be unrestricted at all times.</p>

PRECAUTIONS (CONT.)

	<p>Do not permit chlorine to be present in the feed water.</p>
	<p>Keep out of direct sunlight or high intensity lights, which degrade the housing and fittings over time. Protect unit against freezing to prevent cracking of the filter housings and plastic parts, which may result in water leakage.</p>
	<p>Because filters are limited life and to prevent costly repairs or possible water damage from leaks, the filters must be replaced at end of life.</p>
	<p>If you are going to store and not use your system for an extended period of time (2+ weeks), it is recommended that you remove your membranes, seal them in plastic and put them in a refrigerator.</p>
	<p>Keep the lengths of the tubing short. Longer lengths of tubing will decrease the inlet pressure and ultimately system performance.</p>
	<p>Do not use petroleum products that contain grease, especially on O-rings. A high-quality food-grade silicone is recommended instead.</p>
	<p>When the system is initially turned on, water may temporarily sputter until all of the air is purged. Allow up to 1 hour for any trapped air or noise in the system to subside.</p>
	<p>HyperFilter housings must be replaced every 3 years.</p>
	<p>Unit weight with water is 50 lbs. Mount the system with appropriately rated hardware.</p>
	<p>Do not install unit where leakage or failure may cause damage to property. Utilization of the leak detector is required.</p>
	<p>The flow rate of product water can drastically decrease due to low pressure and low temperature, especially in colder areas or during the wintertime. In some cases, these two factors can affect the performance of the system by as much as 50% or more with loss of flow. A combination of cold water and low pressure can drop flow rates even further. This is the case with all reverse osmosis technology, and it is not unique to the AXEON HYDRO RO system. The ratio of product water to wastewater can also get worse due to low pressure and low temperature. You can overcome some of these issues by choosing the HYDRO RO-1250, which is equipped with an AXEON 1250 booster pump to increase pressure, or by purchasing the booster pump separately.</p>

STAGE 1: EZ-TWIST 5-MICRON SEDIMENT (212254)

The 5-micron sediment filter reduces rust, sand, silt, and other particulates and impurities from the water. Depending on water use and the number of impurities, this filter should be replaced at a minimum of 6,500 gallons of purified water produced.



FILTER	PART # ^A	QTY	REPLACEMENT SCHEDULE
EZ-Twist Sediment Filter	212254	1	3 - 6 months

STAGE 2: EZ-TWIST 5-MICRON CARBON BLOCK (212253)

The 5-micron carbon block filter reduces chlorine, chloramines, and other toxins from the water. Depending on water use and the number of impurities, this filter should be replaced at a minimum of 6,500 gallons of purified water produced.



FILTER	PART # ^A	QTY	REPLACEMENT SCHEDULE
EZ-Twist Carbon Filter	212253	1	3 - 6 months

STAGE 3: EZ-TWIST 5-MICRON CARBON BLOCK (212253)

The 5-micron carbon block filter reduces chlorine, chloramines, and other toxins from the water. Depending on water use and the number of impurities, this filter should be replaced at a minimum of 6,500 gallons of purified water produced.



FILTER	PART # ^A	QTY	REPLACEMENT SCHEDULE
EZ-Twist Carbon Filter	212253	1	3 - 6 months

A. Filters are not sold individually. They are sold in a 3-pack kit (Hydrofarm part # AH3030).

NOTE: EZ-Twist cartridges are installed and replaced by hand as designed. Simply grip, then twist.

FILTER REPLACEMENT SCHEDULE

STAGE 4: HYPERFILTER MEMBRANES (212269)

The AXEON HF-3213-375 HyperFilter is a proprietary membrane that filters down to 0.0001 micron and removes bacteria, viruses, heavy metals, pesticidal residues, and other harmful substances from water. Functional life will vary based on the feed water quality. For most applications, the membrane should be replaced every 6 - 12 months.



FILTER	PART # ^B	QTY	REPLACEMENT SCHEDULE
HyperFilter Membrane	212269	2	6 - 12 months

B. HyperFilter membranes are not sold individually. They are sold in a 2-pack kit (Hydrofarm part # AH2020).

NOTE: CHANGE FILTERS AND MEMBRANES BASED ON THE FILTER REPLACEMENT SCHEDULE.



SYSTEM INCLUDES



1

1. HYDRO RO System
2. EZ-Twist Sediment Filter
3. (x2) EZ-Twist Carbon Filter
4. (x2) HyperFilter Membrane (pre-installed inside the housing)
5. HYDRO System Power Supply
6. HyperFilter Housing Wrench
7. Garden Hose Connector
8. 3/8" x 1/4" Branch Tee (RO-1250)
9. Shutoff Valve
10. Spare Locking Cotter Clips
11. Leak Detector
12. Float Valve

3

3

2



4

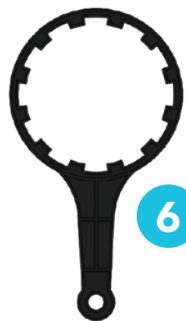

6



7

5



8

10



9

11



12

SYSTEM INCLUDES (CONT.)



13. Black Tubing 1/4" (10 ft)



14. White Tubing 1/4" (10 ft) (RO-1250)



15. (x2) White Tubing 3/8" (10 ft)



16. Blue Tubing 3/8" (10 ft)

17. Booster Pump (RO-1250)^C

18. Booster Pump Transformer (RO-1250)^C



C. Booster pump only comes with RO-1250. Booster pump kit (AH1010) can be purchased separately.



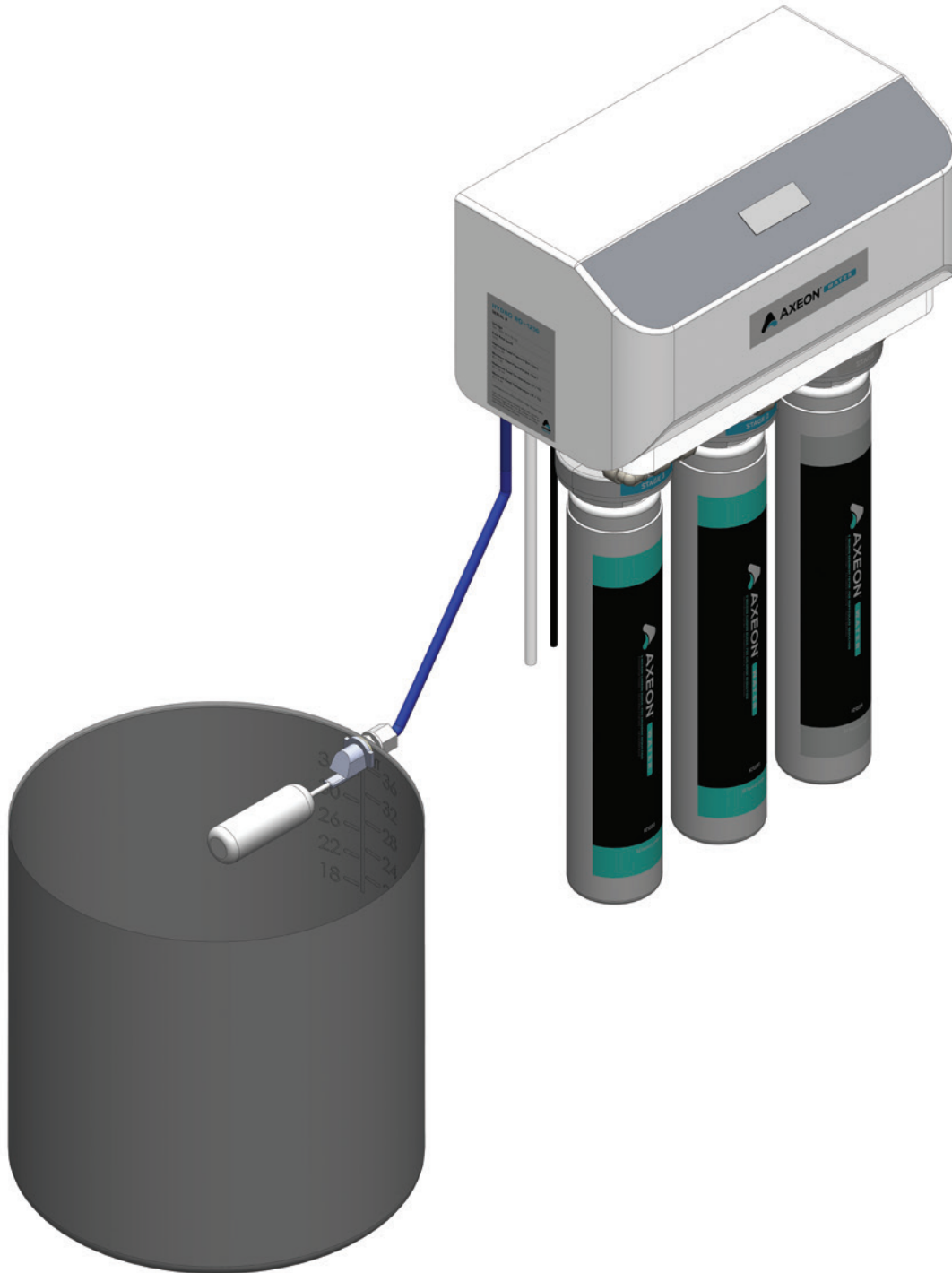

Follow the steps below to set up your AXEON HYDRO RO system. Let's get started!

1. HYPERFILTER MEMBRANE INSTALLATION



Step 1A: Take the HYDRO RO system out from the package. Remove the two screws holding the cover. The screws are located at the bottom of the system towards the back.



Step 1B: Place the unit upright so the AXEON logo is facing you.

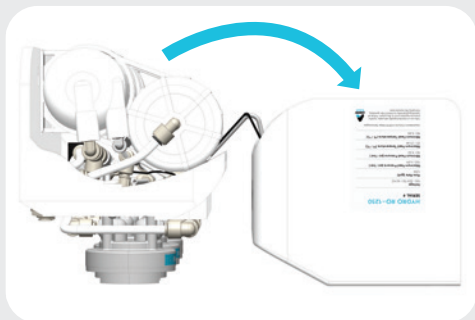

Step 1C: GENTLY lift the cover upwards only a few inches, then carefully lean the top towards yourself, flipping it upside down so it lays on its topside.

The cover will remain connected via wiring harness.

Before we disconnect the HyperFilter housings, let's review how the QC fittings and locking cotter clips work.



LOCKING COTTER CLIPS

Certain QC fittings come equipped with secure-lock cotter clips. **Do not throw them away.** The cotter clip provides an extra layer of protection by securely locking tubing into the QC fitting.

Before disconnecting or connecting tubing into a QC fitting, first remove the cotter clip and set it aside. Once the tubing is inserted back into the QC fitting, put the blue locking cotter clip back in place to lock the connection.



DISCONNECTING QUICK CONNECT (QC) FITTINGS

Ensure system is depressurized before removing fittings, then push in the collet evenly against the face of the fitting. With the collet held in this position, the tube can be removed by simply pulling. The fitting can then be re-used. If the tubing has been removed several times, you may see score marks on the ends, which can lead to leaks. It is best to cut the end off of the tubing with a sharp blade, being careful to cut straight across. Any angle to the cut can cause a leak.

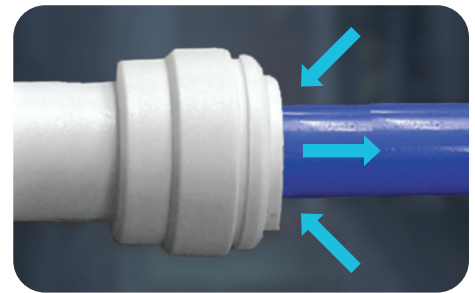

CONNECTING QUICK CONNECT (QC) FITTINGS

Push tubing firmly into the fitting all the way until the tube stops. The collet (gripper) has stainless steel teeth which hold the tube firmly in position, while the O-ring provides a leak proof seal. Pull tubing to check for security. If some tube pulls out, then push it all the way in again until it stops. It is good practice to test the system prior to leaving site and/or before use.

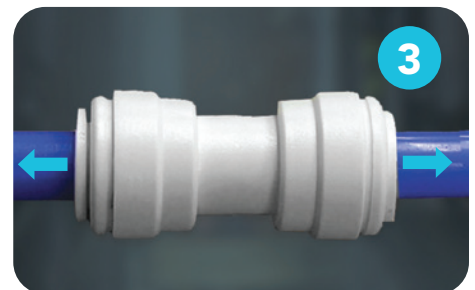



Step 1D: Disconnect the locking cotter clips and tubing going to the HyperFilter housing cap, then unscrew the cap, using the included wrench, in a counterclockwise direction. Repeat this step for the 2nd HyperFilter housing.

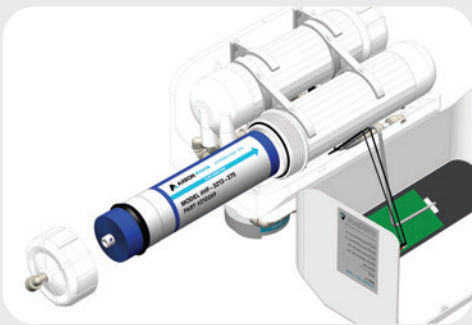

Step 1E: Remove the HyperFilter membrane from the packaging and lightly lubricate the brine seal and O-rings with a non-petroleum-based lubricant, such as Dow Corning 111 silicone (not included).

DO NOT USE A PETROLEUM-BASED LUBRICANT.

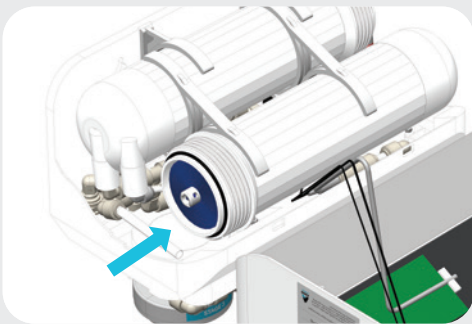

Step 1F: Align the HyperFilter membrane so that its arrow goes into the HyperFilter housing and away from the housing cap. Next, with a smooth and constant motion, push the HyperFilter membrane into the housing, making sure it's fully seated in the housing.



Step 1G: Re-install the end cap by turning it in a clockwise direction until firmly tightened. Reconnect the tubing to the cap and re-install the locking cotter clips. Be careful that you do not over-tighten, pinch, or cut any O-rings when re-installing the end caps.



Step 1H: Re-install the cover. Engage the tabs located in the back. Make sure the power cables connected to the cover are aligned in the middle of the cover and that the membrane housings are aligned to allow the cover to sit properly. Next, re-install the screws that secure the cover.

NOTE: Only install or replace membranes with RO system on the ground. Do not replace membranes while system is mounted on wall.

2. PREPARING TO MOUNT THE RO SYSTEM



Step 2A: This system should be installed in a cool and dry place. Keep it away from direct sunlight, heat, moisture, and chemicals. It should be installed in an area where if a failure occurs and it leaks, it won't cause excessive damage.

Step 2B: The system weighs 50 lbs when it contains water. When mounting, use appropriately rated hardware for the system weight and wall surface type.

Step 2C: Make sure that the unit is mounted with a minimum of six inches of clearance between the bottom of the filter cartridges and the ground. This is to allow for adequate space when replacing cartridges. The RO system's power cord is 59" long.

Step 2D: Use the mounting guide on page 30 to help align holes for mounting. Before placing the system on the wall, grab the sides of the cover and carefully flip it onto its front so you can see the backside of the unit to make the tubing connections. **Never move the system by grabbing the filter cartridges.**

3. TUBING CONNECTIONS FOR RO-750 AND RO-1250

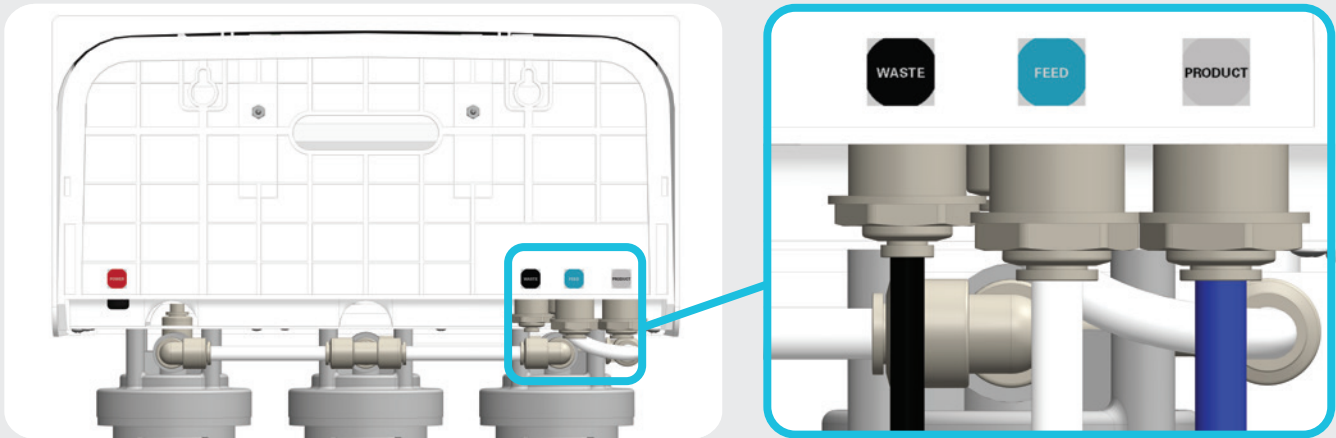

Step 3A: Connect the 3/8" white tubing from the feed water source using the included garden hose adapter to the back of the system's "FEED" port, which is labeled.

Step 3B: Use the 1/4" black tubing from drain, making sure it is free and unrestricted (no back pressure) and connect it to the back of system's "WASTE" port, which is labeled.

Step 3C: Use the 3/8" blue tubing from the included float valve or point-of-use and connect it to the back of the system's "PRODUCT" port, which is labeled.

Step 3D: Now with the tubing connected, you can mount the RO system on the wall.

4. FILTER INSTALLATION

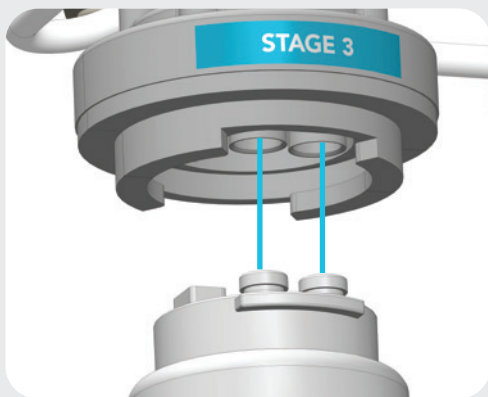

Step 4A: Remove the new EZ-Twist cartridges from the packaging and ensure all connection points and keys are aligned to the head. Reference and match up the correct cartridge to the correct stage.

- Stage 1: Silver Filter, #212254
- Stage 2: Blue Filter, #212253
- Stage 3: Blue Filter, #212253



Step 4B: Slide the filter up into the head vertically, then rotate the filter to the right until it stops. Do this for all three filter cartridges, making sure each filter stage matches the corresponding label on the head.

If installing the RO-1250 system, skip to Stage 8 (page 17).

If installing the RO-750 system, continue with the steps below. It's time to mount the provided float valve to your product reservoir or water tank (not included). This step requires drilling a hole through your product reservoir or water tank.

5. FLOAT VALVE INSTALLATION FOR RO-750

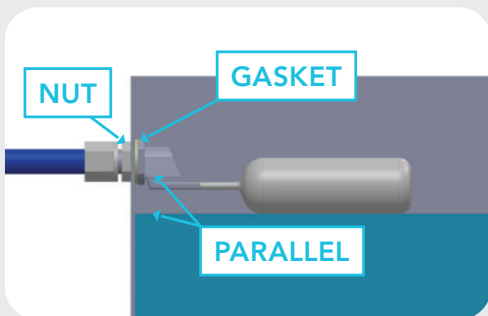

Step 5A: Begin by identifying the maximum water level height. Drill a 1/2" hole at the max water line and remove any plastic debris from inside the water tank.

Step 5B: Push the threaded end of the float valve from inside the water tank through the drilled hole and out. Make sure that the gasket is on the inside of the tank.

Step 5C: Connect the nylon nut on the outside of the water tank to secure the float valve. Adjust the float so that it is vertically level and not at an angle. This is crucial so the float is not obstructed in any way as it moves up or down.

Step 5D: Once level and secure, connect the 3/8" blue tubing to the float valve inlet.



Warning: We do not recommend operating the system without the float valve. It is a security measure designed to stop your reservoir from overflowing.

6. POWER CONNECTION FOR FOR RO-750



Step 6A: Mount the system and connect the power supply to the RO system's power port located on the back right of the system.

Now with the power connected and the HyperFilter membranes, filters, tubing connections, and float valve all installed, the system is now ready to operate! Continue to the *Smart Controller Functionality Explained* portion of the manual to learn how the system features operate.

7. MOUNTING THE BOOSTER PUMP FOR THE RO-1250 (OPTIONAL)



Step 7A: Mount the pump on the wall using appropriately rated hardware. Note that the booster pump's power cord is 85" long.

Step 7B: Make sure to align the pump vertically, having the rounded top of the pump face up and the flat part of the pump facing down.

Step 7C: Use mounting guide on page 31 to help align holes for mounting. Do not mount the pump more than 4 feet from the RO System.

8. BOOSTER PUMP TUBING CONNECTIONS FOR RO – 1250

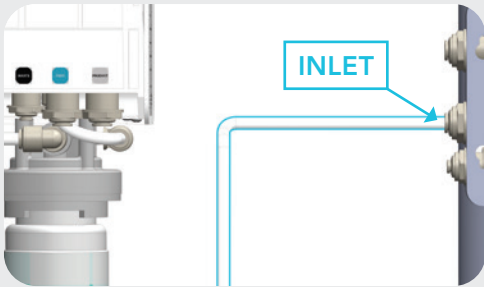

Step 8A: It's time to connect the tubing coming from the RO system to the booster pump. For feed water connection, connect 3/8" white tubing from feed source using the included garden hose adapter to the port on the right side of the pump labeled "INLET".

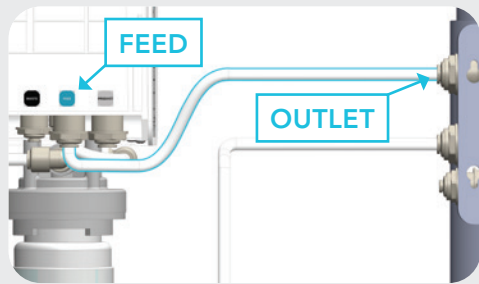

Step 8B: Connect 3/8" white tubing coming from the RO system's port labeled "FEED" to the pump port labeled "OUTLET".

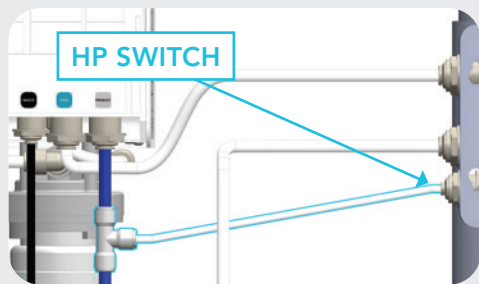

Step 8C: Install included tee on blue tubing labeled "PRODUCT" coming from RO system's port. Connect 1/4" white tubing to the port on the right side of the pump labeled "HP SWITCH" and to the tee. Install 3/8" blue tubing to tee to extend the "PRODUCT" line.



Warning: Never install the shut-off valve on the black waste water line! This has to be able to drain waste water freely and without obstruction.

9. FLOAT VALVE INSTALLATION FOR RO-1250

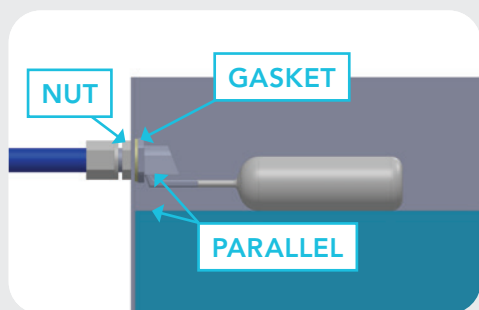

Step 9A: Begin by identifying the maximum water level height. Drill a 1/2" hole at the max water line and remove any plastic debris from inside the water tank.

Step 9B: Next, push the threaded end of the float valve from inside the reservoir and out, making sure the gasket is on the inside of the water tank.

Step 9C: Connect the nylon nut on the outside of the water tank to secure the float valve. Adjust the float so that it is vertically level and not at an angle. This is crucial so the float is not obstructed in any way as it moves up or down.

Step 9D: Once level and secure, connect the 3/8" blue tubing to the float valve inlet.



Warning: We do not recommend operating the system without the float valve. It is a security measure designed to stop your reservoir from overflowing.



10. POWER CONNECTIONS FOR RO-1250



Step 10A: Connect the larger pump power supply to the pump's power port.



Step 10B: Connect the smaller RO system power supply to the RO system's power port.

Now with the power connected and the HyperFilter membranes, filters, tubing connections, and float valve all installed, the system is now ready to operate! Continue to the *Smart Controller Functionality Explained* portion of the manual to learn how the system features operate.



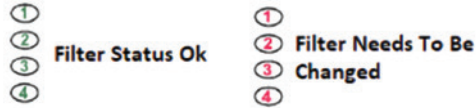

SYSTEM SCREEN KEY

NOTE: Upon system start up, don't be alarmed by high TDS levels. TDS levels will slowly decline for up to the first 3 days of operation.

- **Power On:** After powering on, the system screen will flash all indicator lights.
- **Flush:** Upon system startup, a 60 second flush will begin before the system will start to work. During operation, the system will automatically perform a 30 second system rinse every 2 hours. This helps extend membrane life.
- **Working:** After the 60 second flush has been completed and no errors have been detected, the system will start the filtration process. The working light will be flashing blue.
- **Full Operation:** The system will stop its filtration process when the water level in the tank reaches the full/maximum water level. When the tank is full, the float rises, causing the valve to close. This produces pressure in the tubing, which the pressure sensor monitors, and stops the system from operating. The green full light will be on, indicating that the storage tank/reservoir is full.
- **Start Operation:** The system starts when the water level in the tank drops. As the water level drops, so does the float. As a result of this, the valve opens, which releases pressure in the tubing. The pressure sensor monitors this and turns the system on to start the filtration process.
- **Low:** If feed water pressure is lower than the required 40 PSI (according to low pressure switch), the "low" icon on the LCD screen will be on and the system will stop its filtration process.
- **TDS:** The screen shows both feed and product water when the system is running. When the exiting clean product water TDS reaches 90 ppm, an alarm will be triggered reminding customers to replace the HyperFilters.
- **Filter Status:** If filters are good, the light indicator (1 2 3 4) will be green. When the filters reach the end of their life, the light will turn red.
- **Filter Selection:** By pressing the filter select button for three seconds, the #1 filter light indicator will start blinking with green and red color. Press the filter select button again and the #2 filter will start blinking green and red. If the filter select button is held for more than five seconds, the selection will be canceled.
- **Filter Reset:** After the filter select button turns to the relevant filter, the relevant numbers will start blinking. Press and hold the filter reset button for 3 seconds and the filter status will be reset.
- **Check:** This feature was removed but the icon still appears on the system screen. It is not active.

HYPERFILTER MEMBRANE REJECTION CHART

The HyperFilter membrane rejection chart can be very helpful as a general guideline, but is not a guarantee. Every water source has different chemistry, temperature, and TDS, so it is best to test your water thoroughly to determine your unique water profile.

A good place to start is EWG.org. Type in your zip code to determine what contaminants (if any) you may be dealing with.

ION	SYMBOL	% REJECTION
Aluminum	Al ⁺³	97-98
Ammonium	NH ₄ ⁺	85-95
Borate	B ₄ O ₂ ⁻²	30-50
Boron	B	60-70
Bromide	Br ⁻	93-96
Cadmium	Cd ⁺²	93-97
Calcium	Ca ⁺²	95-98
Chloride	Cl ⁻	92-98
Chromate	CrO ₄ ⁻²	85-95
Copper	C _u ⁺²	96-98
Fluoride	F ⁻	93-95
Iron	Fe ⁺²	96-98
Lead	Pb ⁺²	95-98
Manganese	Mn ⁺²	97-98
Magnesium	Mg ⁺²	95-98
Mercury	Hg ⁺²	95-97
Nickel	Ni ⁺²	97-98
Nitrate	NO ₃ ⁻	90-95
Phosphate	PO ₄ ⁻³	95-98
Polyphosphate	PolyP	96-98
Potassium	K ⁺	92-96
Silica	Si	85-90
Silicate	SiO ₂ ⁻²	92-95
Silver	Ag ⁺	95-97
Sodium	Na ⁺	92-98
Sulfate	SO ₄ ⁻²	96-98
Thiosulfate	S ₂ O ₃ ⁻²	97-98
Zinc	Zn ⁺²	97-99
Arsenic	As	90-95

STAGE 1: EZ-TWIST 5-MIC SEDIMENT (212254)

The melt blown sediment cartridges are made of 100% polypropylene material. These fibers are carefully woven using a proprietary process to ensure the highest level of filtration performance. These cartridges have the advantage of not using any glues or additives which could foam, discolor, or cause any other undesirable effects. In addition, the polypropylene construction provides a high level of chemical compatibility.

- Operating pressure: 40-100 psi (2.76-6.89 bar)
- Operating temperature: 40 °F-85 °F (4 °C-29 °C)
- 5-micron nominal filtration
- True multi-layered depth filtration
- Exceptionally low pressure drop
- Proposition 65 compliant
- Meets NSF42 standards
- Industry-leading performance

STAGE 2 AND 3: EZ-TWIST 5-MIC CARBON (212253)

The carbon block cartridges are manufactured using activated coconut shell carbon to provide the highest level of chlorine and odor reduction. In addition, this combination of high-performance carbon, unique binders, and proprietary manufacturing processes delivers exceptionally low pressure drop, high dirt holding capacity, and excellent contaminant reduction.

- Operating pressure: 40-100 psi (2.76-6.89 bar)
- Operating temperature: 40 °F-85 °F (4 °C-29 °C)
- 5-micron nominal filtration
- No release of carbon fines
- Exceptionally low pressure drop
- Proposition 65 compliant
- Meets NSF42 standards
- Industry-leading performance

STAGE 4: 3213 HYPERFILTER MEMBRANES (212269)

Hyperfiltration system membranes are recognized as one of the industry's most reliable and highest performing membranes that deliver consistent performance and quality. Advanced membrane technology and manufacturing processes allow these membranes to deliver consistent results. These membranes are shipped dry for an indefinite shelf life, easier handling and lighter shipping weight.

- Dry rolled element—extended life
- 96%+ PPM rejection
- High flow flat sheet material
- Improved system performance
- Superior quality and cost savings
- Individually tested and sanitized

SYSTEM SPECIFICATIONS

MODELS	RO – 750	RO – 1250
Configuration	Single Pass	Single Pass
Standard Recovery %	72	72
Permeate Flow Rate (GPM)	0.52	0.87
Concentrate Flow Rate (GPM)	0.20	0.35
Feed (inch)	3/8	3/8
Permeate (inch)	3/8	3/8
Concentrate (inch)	1/4	1/4
Membrane Quantity	2	2
Membrane Size	3213	3213
Nominal TDS Rejection %	97	97
Vessel Quantity	2	2
Pump Type	N/A	Diaphragm
Motor Voltage	N/A	24VDC
Noise	N/A	50db
Standard Voltage and Amp Draw	115V, 60Hz, 1PH, 1.0A	115V, 60Hz, 1PH, 6.0A
Approximate Dimensions W x D x H (in)	15.75 x 9 x 27	15.75 x 9 x 27
Approximate Weight (lbs)	20.5	27.4

NOTE: Permeate is your product water. Concentrate is your waste water.

MINIMUM AND MAXIMUM OPERATING CONDITIONS

CONDITION	MINIMUM	MAXIMUM
Inlet Pressure (psi / bar)	40 / 2.76	100 / 6.89
Inlet Temperature (°F / °C)	40 / 4.44	85 / 29.44
Inlet TDS (mg/L)	50	1,000
Inlet Hardness (mg/L)	0 (0 grain)	171 (10 grain)
Inlet Chlorine (mg/L)	0	1.0
Inlet Iron (mg/L)	0	0.1
Inlet Manganese (mg/L)	0	0.05
Inlet pH	2	11
Inlet Turbidity	0	1 NTU

A one year warranty against manufacturer's defects comes with each unit.

This does not include clogged or damaged pre-filters or RO HyperFilter membranes due to lack of regular maintenance or excessive sediment, chlorine, chloramines, iron, silica, manganese, sulfur or PPM in the source water. This warranty also excludes damage caused by using the unit outside of the specified operating parameters. Do not operate unit if incoming pressure exceeds 100 psi or there is a problem with water hammer or pressure spikes.

Change both HyperFilter housings every three years (available through your local dealer or AXEON Water).

The manufacturer believes the information and data contained herein to be accurate and useful. The information and data are offered in good faith, but without guarantee, as conditions and methods of use of products are beyond the manufacturer's control. The manufacturer assumes no liability for results obtained or damages incurred through the application of the presented information and data.

It is the user's responsibility to determine the suitability of the products for the user's specific end uses.

AXEONhydro.com

WARNING: USING NON-ORIGINAL REPLACEMENT FILTERS OR MEMBRANES WILL VOID THE WARRANTY.

Q: Why is the system leaking?

A: This can be due to various reasons, including lack of Teflon tape at threaded fittings, tubing not being pushed in all the way to the quick connect fittings, or improperly seated O-rings in pre-filter and membrane housings. It is also important to make sure the ends of the tubing have a clean cut before inserting them into the quick connect fittings.

Q: Why is the TDS high?

A: This is typically due to deterioration of the membrane because of exposure to chlorine. The purpose of the carbon filter is to remove chlorine from the water. If it isn't changed on schedule, chlorine will pass through to the membrane and degrade it, causing more water to flow out the product line and increase the TDS.

Q: Why is the pH of the purified water higher/lower than the source water?

A: The pH of the purified water depends entirely on source water chemistry. Customers can experience either slightly lower or higher pH after filtration. This is completely normal for reverse osmosis technology. Since RO water is almost pure H₂O and has no ability to buffer pH, the actual pH reading will not be accurate until you add minerals back.

Q: The system is brand new; why is the flow rate of purified water so low?

A: The system's GPD capacity is achieved when you have the following conditions for your source water: 77 °F, >500 PPM, 80 PSI. If your source water is colder than this, your inlet pressure is lower, or your PPMs are significantly higher, then you will experience less than the rated GPD flow rates. If your inlet feed pressure is too low, you may need to purchase the AXEON 1250 Booster Pump Kit to help the system reach operating pressure.

Q: My product flow rate has been decreasing. What could be happening?

A: It could be a few different things. First, check for leaks and kinks in the lines. If there are no leaks or kinks, you may need to replace your HyperFilter membranes. If you've replaced the membranes and the feed water pressure has not increased, you may need to purchase the AXEON 1250 Booster Pump Kit to help the system reach operating pressure.

HYPERFILTRATION RO-750

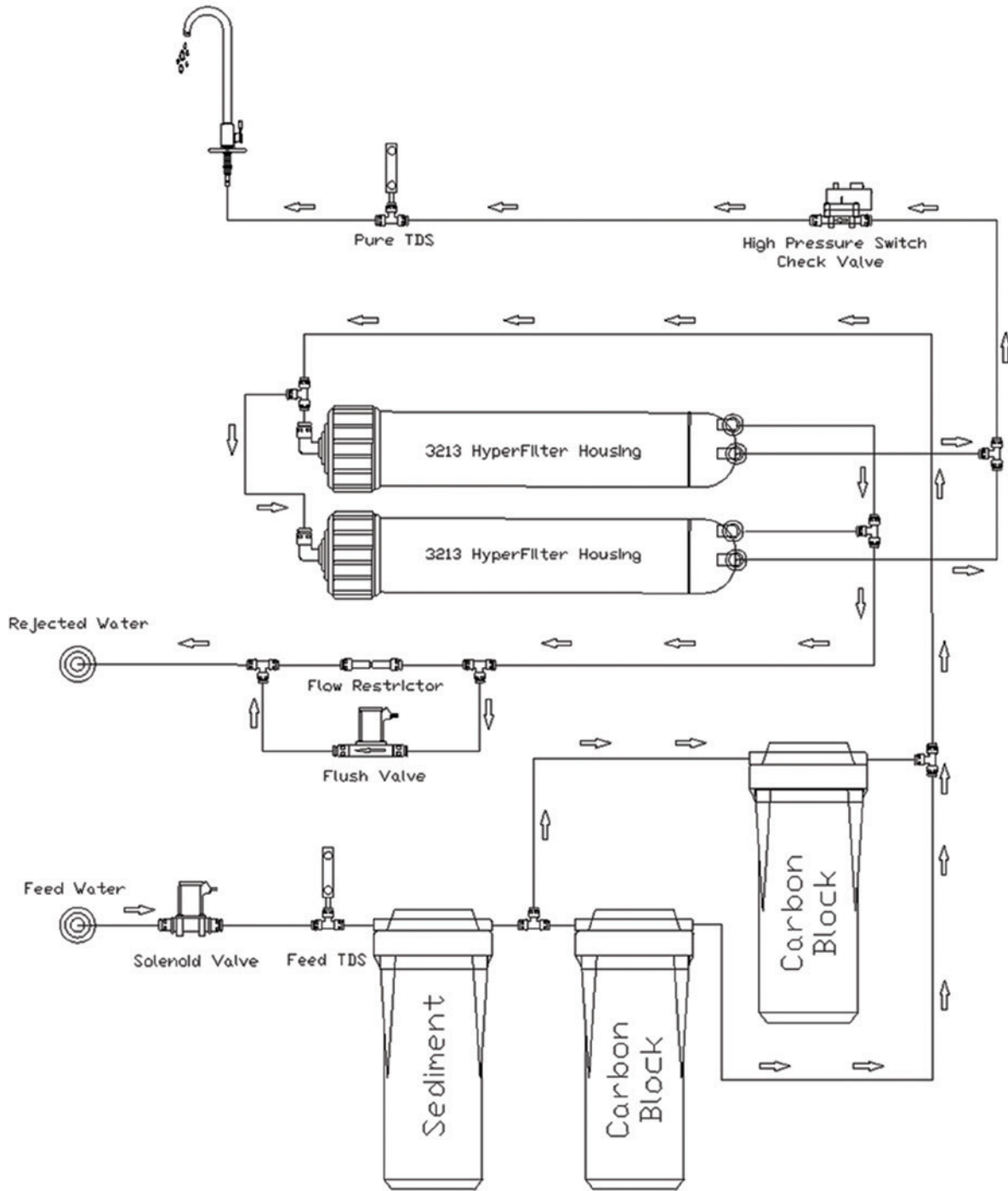

HYPERFILTRATION RO-1250

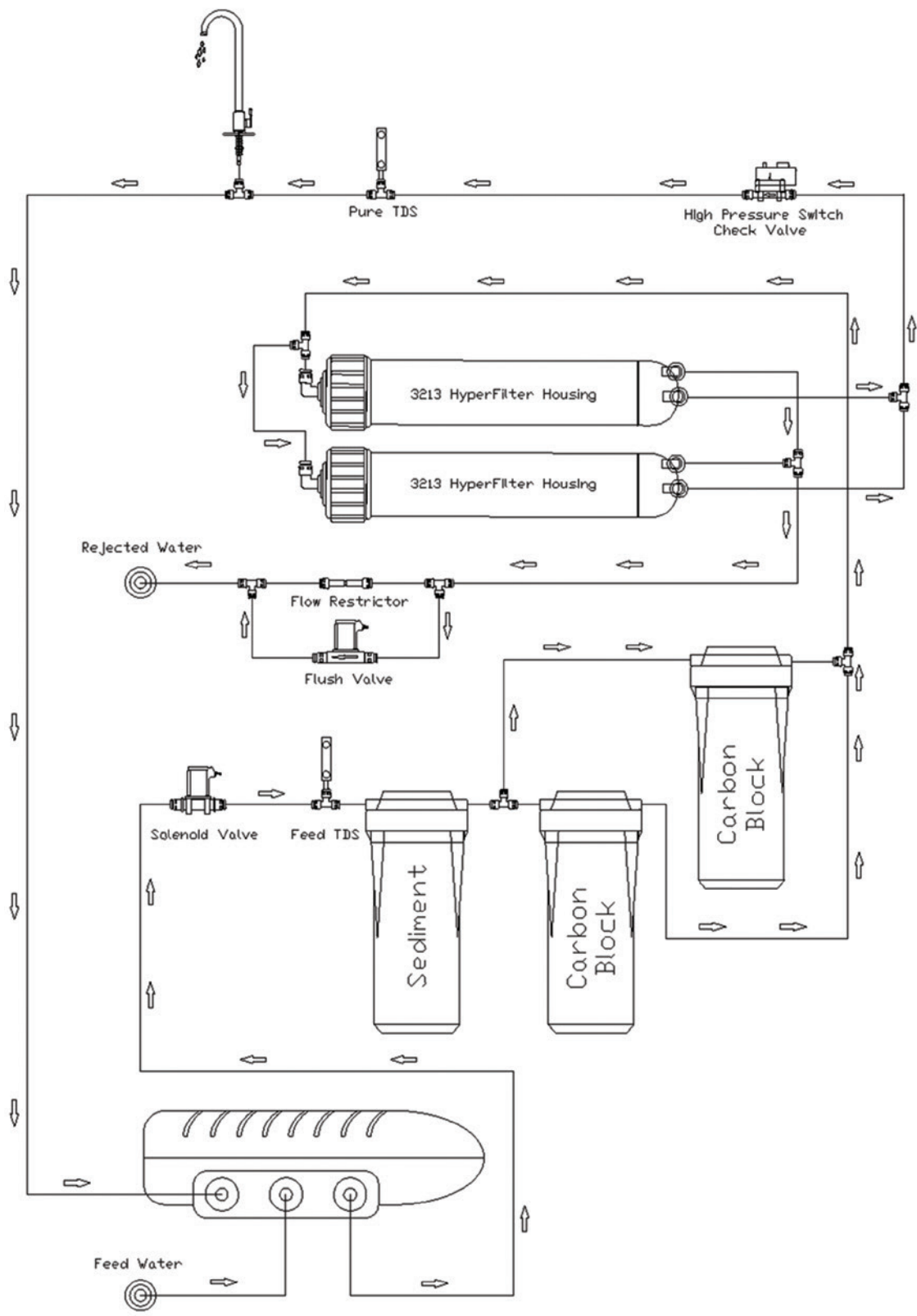

RO SYSTEM MOUNTING DIAGRAM

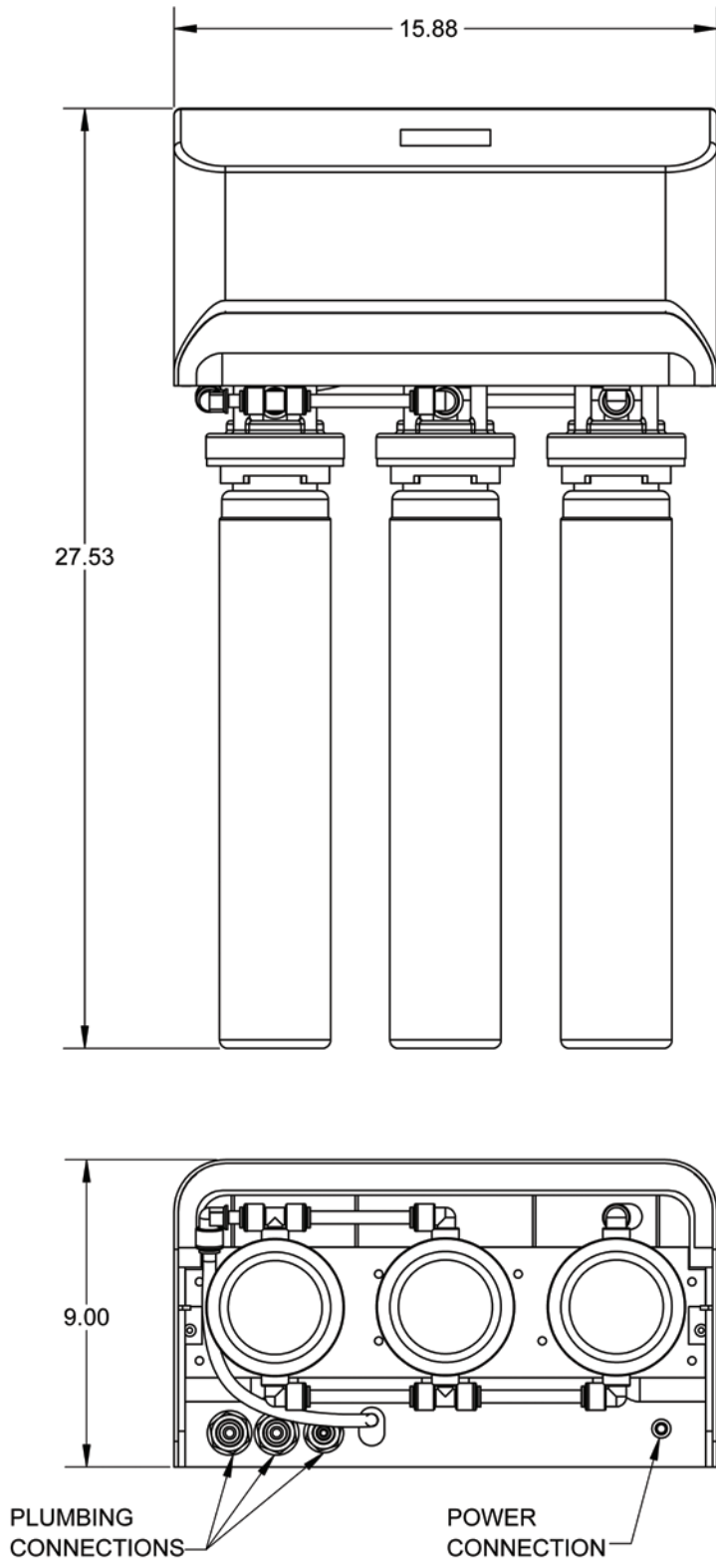

RO SYSTEM MOUNTING DIAGRAM

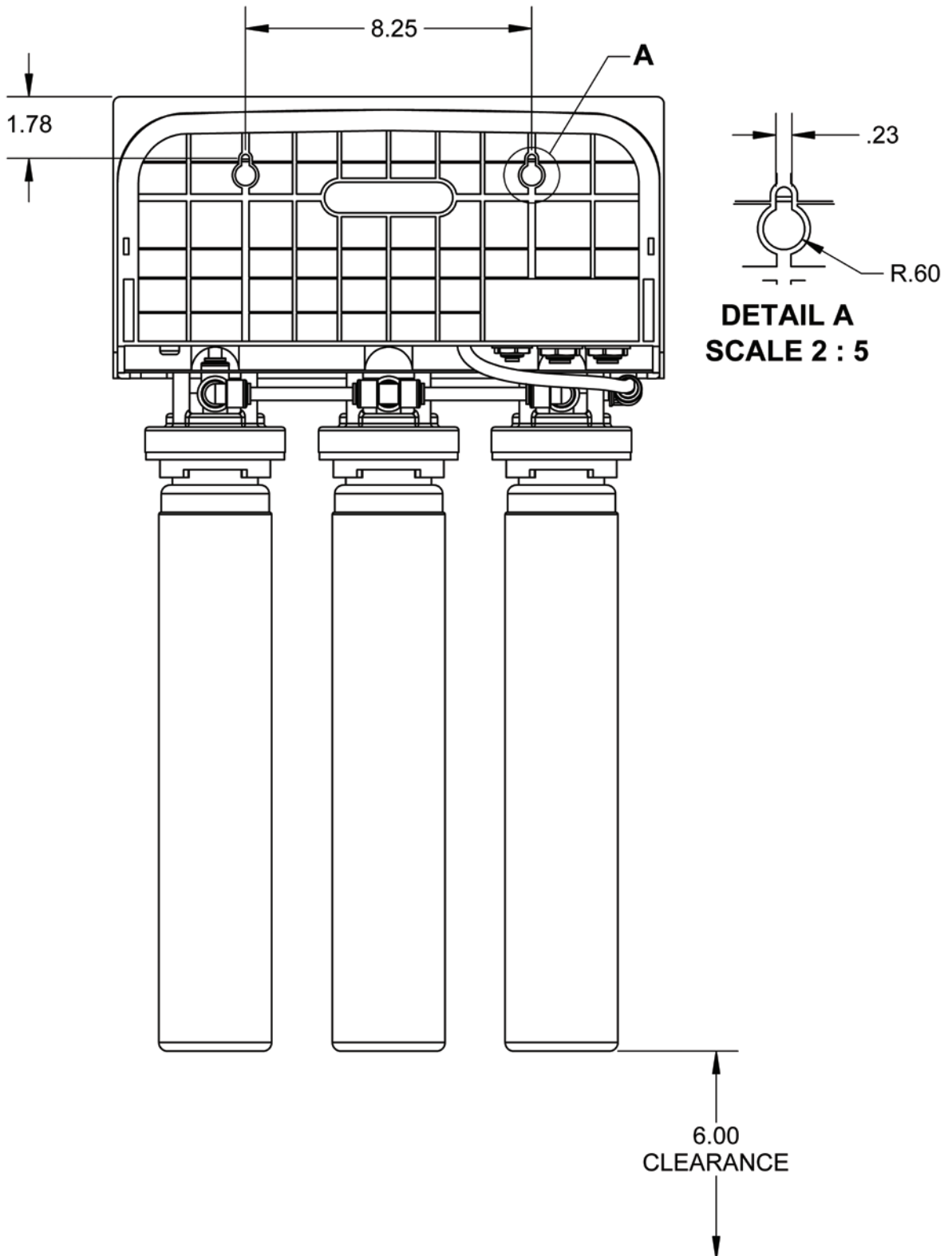

**RO SYSTEM
MOUNTING
DIAGRAM***

*True to size

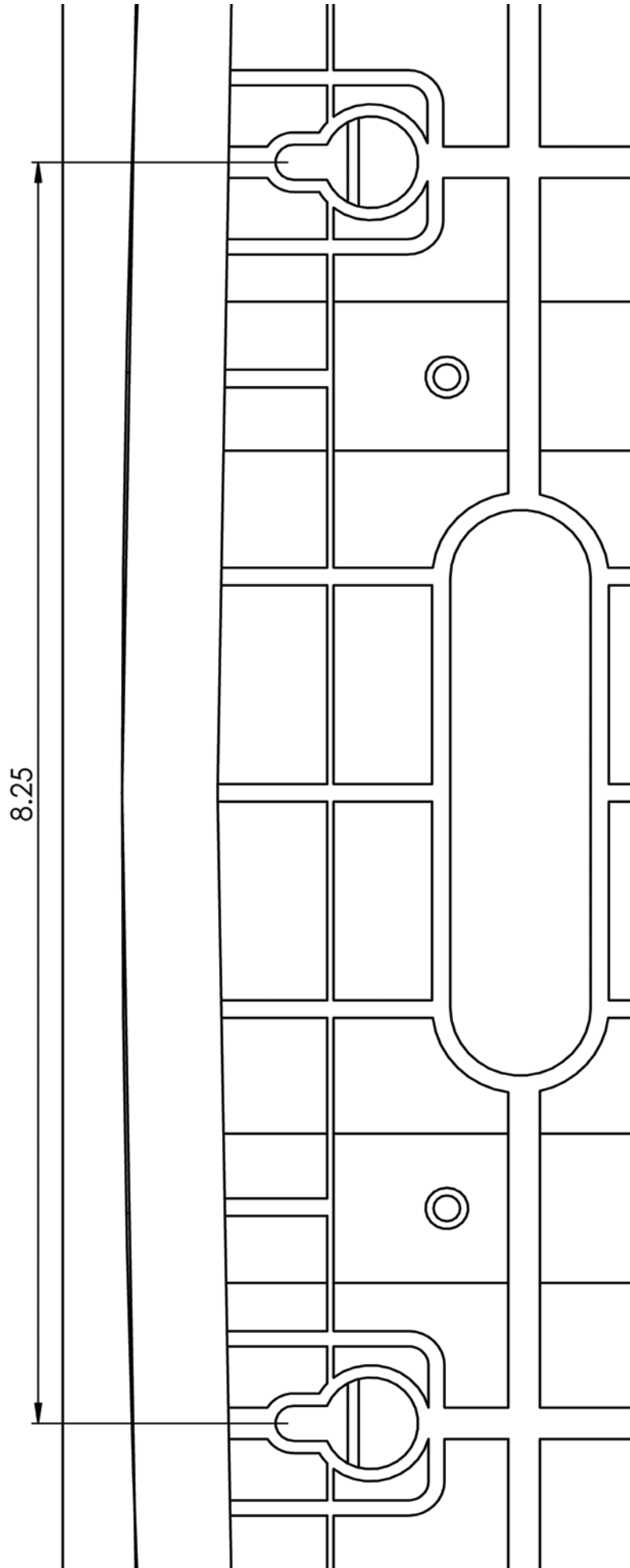

BOOSTER PUMP MOUNTING DIAGRAM*

*True to size

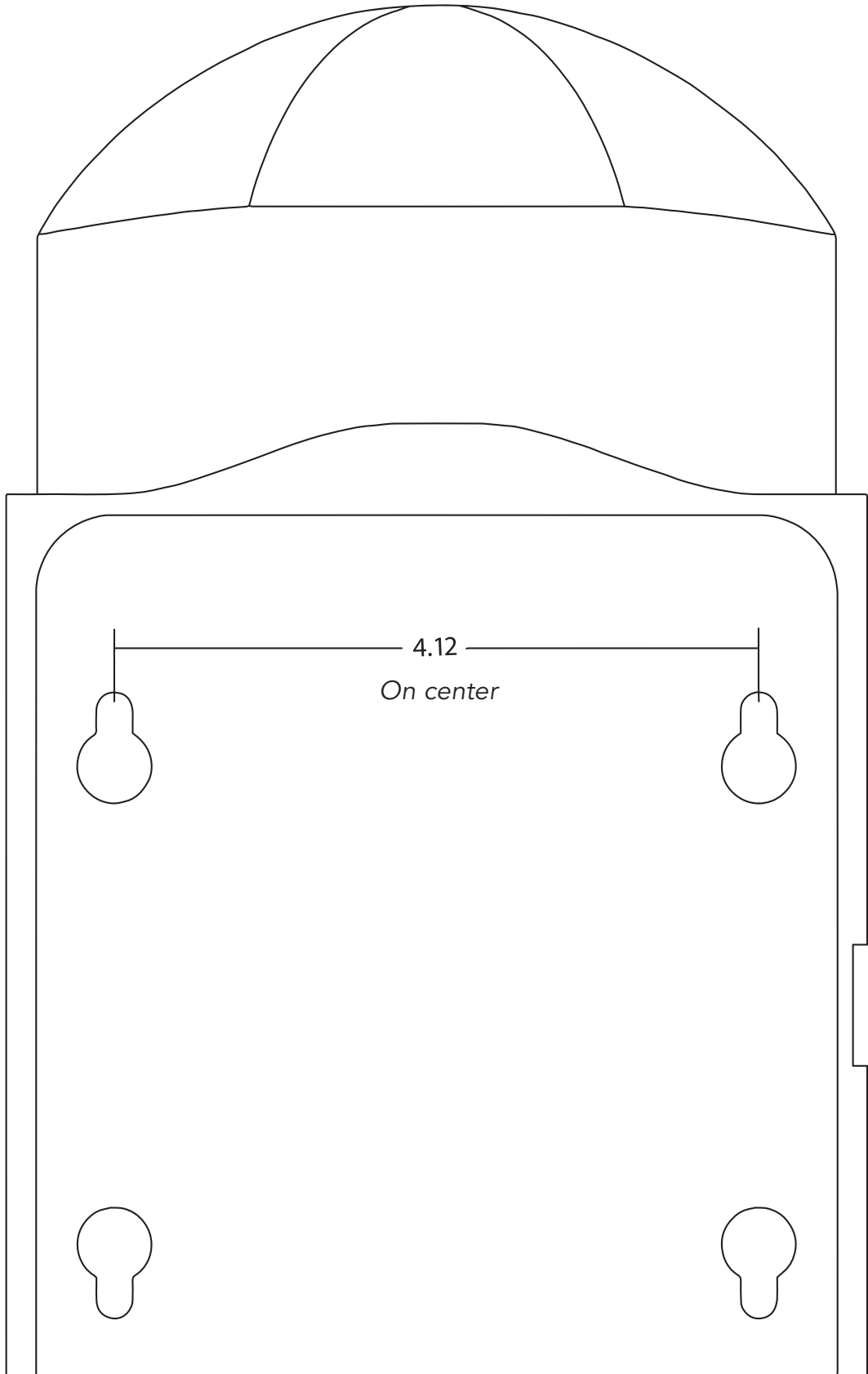

FILTER REPLACEMENT LOG

MEMBRANE	DATE

CARBON OR PRE-FILTER	DATE



AXEONhydro.com

MKT-694-B 08/23